



Handling instructions

Silent Tools™ adaptors for Coromant EH



●●●● SilentTools®

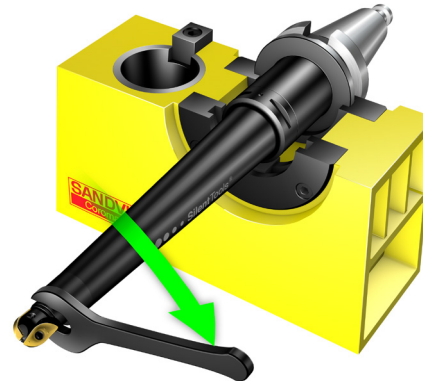
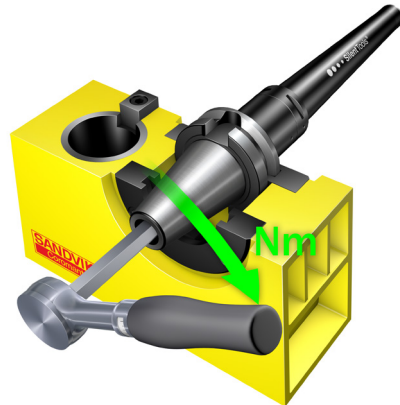
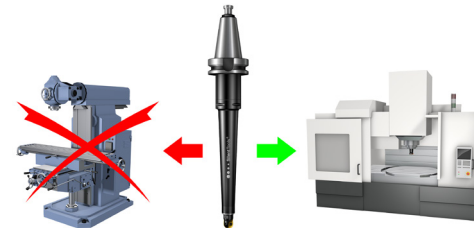
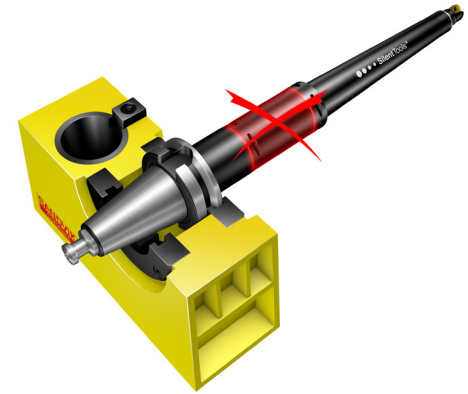
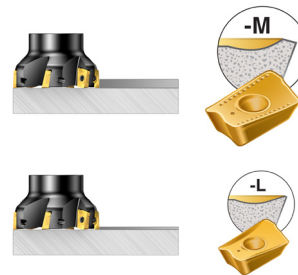
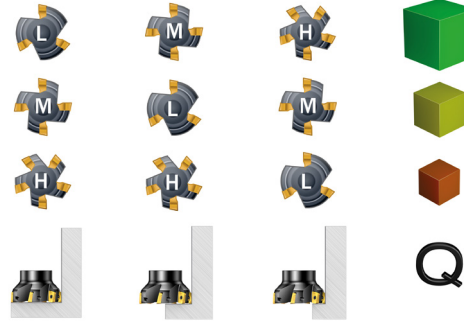
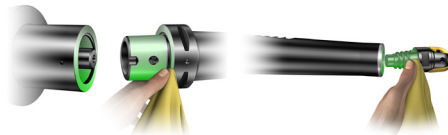
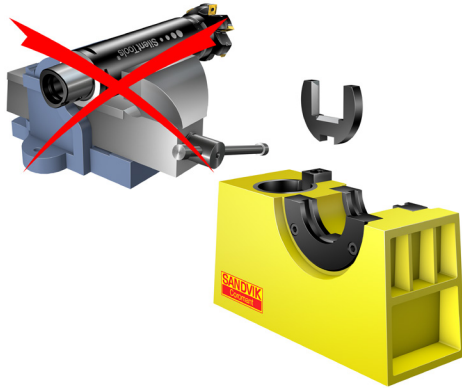

Head office:
AB Sandvik Coromant
SE-811 81 Sandviken, Sweden
www.sandvik.coromant.com
E-mail: info.coromant@sandvik.com

92029
© AB Sandvik Coromant
2015.01 Rev 15.1



Coromant Capto size	Max torque	
	Nm	ft-lbs
C3	45	33
C4	55	40
C5	95	70
C6	170	125
C8	170	125
C10	380	277

Slitting cutter and Silent Tools™
application guide
www.sandvik.coromant.com